

SCHWINGMETALL® Spezialelemente

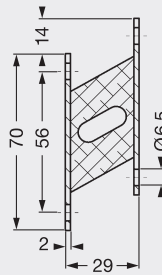

Form-Nr. 25187

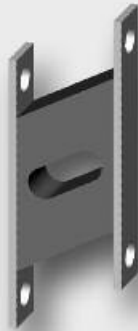
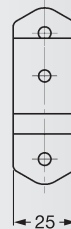
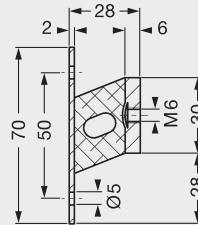

Form-Nr. 25284

Geräteelemente

Federsteifigkeiten			max. Belastungen			Masse Stück [kg]	Elastomer Härte [Shore A]	Form-Nr.	Artikel-Nr.
C _x [N/mm]	C _y [N/mm]	C _z [N/mm]	F _x [N]	F _y [N]	F _z [N]				
20	4	4	60	20	40	0,035	40	25187	3946403000
39	6	6	110	40	80	0,035	55	25187	3946203000
60	10	10	180	50	100	0,035	65	25187	3946103000
54	9	9	125	45	90	0,072	40	25284	3946401000
104	16	16	250	75	150	0,072	55	25284	3946201000
160	25	25	360	100	200	0,072	65	25284	3946101000
43	8	8	130	40	100	0,076	40	21423	3946404000
83	14	14	205	70	200	0,076	55	21423	3946204000
128	23	23	300	120	250	0,076	65	21423	3946104000
73	20	20	180	100	200	0,127	40	24332	3946406000
140	37	37	350	185	250	0,127	55	24332	3946206000
215	57	57	500	200	280	0,127	65	24332	3946106000

Belastungsrichtungen

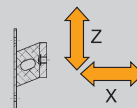

Belastungsrichtungen

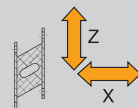

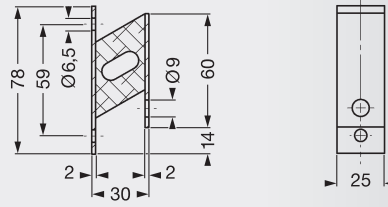

Form-Nr. 21423

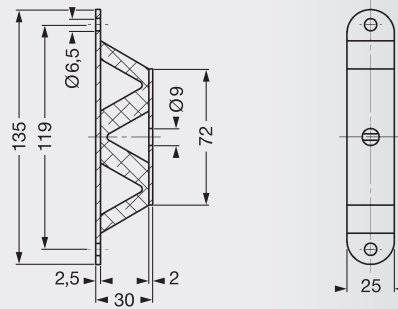

Form-Nr. 24332

Belastungsrichtungen

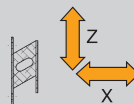

Belastungsrichtungen

